

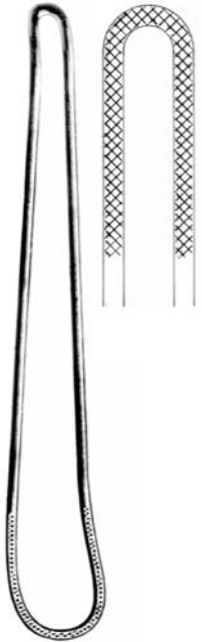

**Brünings**

19,0 cm 17-006-19



**Frenzel**

16,5 cm 17-007-16



**Hartmann**

15,0 cm 17-011-15

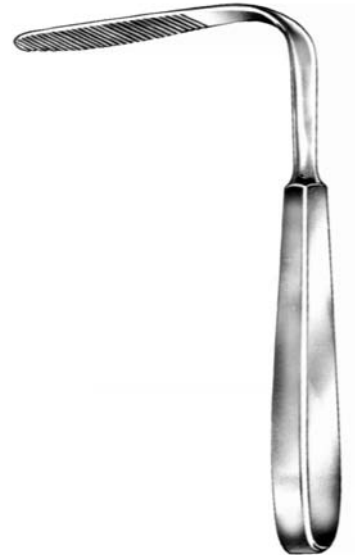

**Tobald**

16,0 cm 17-013-16



17-017-01



17-017-02

**Weder, 15,0 cm**



**Heister**

13,0 cm 17-022-13



**Molt**

10,0 cm 17-023-10

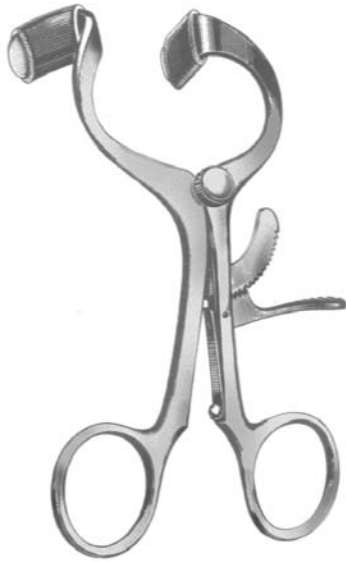

**Doyen-Jansen**

14,0 cm 17-026-14



**Denhardt**

12,0 cm 17-028-12



**Rosier-König**

16,0 cm 17-029-16  
 19,0 cm 17-029-19



**Whitehead**

11,0 cm 17-031-11  
 13,0 cm 17-031-13  
 15,0 cm 17-031-15

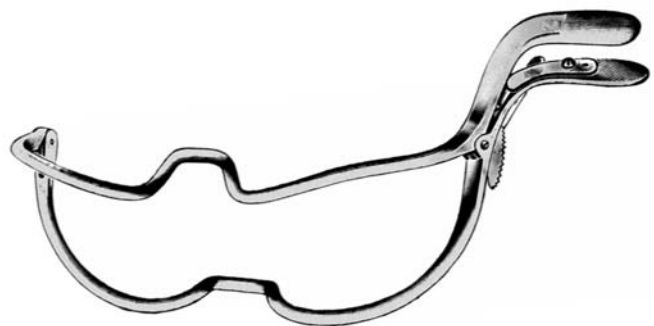

**Whitehead-Jennings**

9,0 cm 17-033-09  
 11,0 cm 17-033-11  
 13,0 cm 17-033-13  
 15,0 cm 17-033-15



**Dingmann, komplett/complete**  
**17-035-00**

bestehend aus/consisting of:

- 2 drehbare Wangenhalter**  
2 rotating cheek holders
- 2 bewegliche Zahnhaken und Fadenführer**  
2 movable tooth hooks and thread guide
- je 1 Zungenspatel Dingmann 17-056-01,-02,-03  
each 1 Tongue blade Dingmann

**Dingmann, Griff allein/Handle only**  
**17-035-01**



**Davis-Boyle**

- 17-041-00 Erwachsene/adult
- 17-042-00 Kleinkinder/infant
- 17-043-00 Kinder/children



**Kilner-Doughty**  
**17-044-19**



**McIvor**  
**17-045-00**



**Russel-Davis**

29x 67 mm **17-050-01**  
 33x 75 mm **17-050-02**  
 38x 85 mm **17-050-03**  
 40x 92 mm **17-050-04**  
 46x100 mm **17-050-05**



**Gast**

28x64 mm **17-052-01**  
 34x74 mm **17-052-02**  
 38x87 mm **17-052-03**

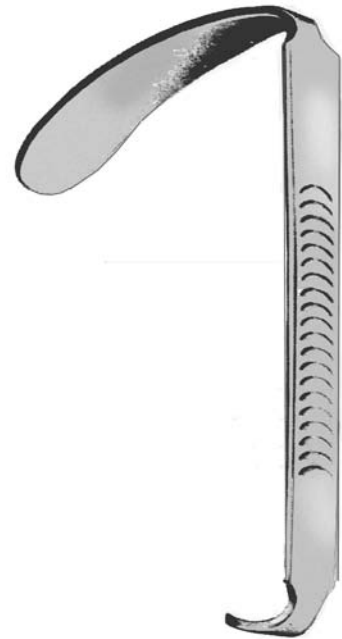

**Mclvor**

25x55 mm **17-054-01**  
 25x62 mm **17-054-02**  
 25x75 mm **17-054-03**



**Davis-Boyle**

19x 25 mm **17-055-01**  
 25x 62 mm **17-055-02\*** \*mit Ätherrohr  
 25x 75 mm **17-055-03\*** \*with anesthetic tube  
 25x 92 mm **17-055-04\***  
 25x108 mm **17-055-05\***



**Dingmann**

24x62 mm **17-056-01**  
 28x65 mm **17-056-02**  
 31x75 mm **17-056-03**



**Negus Bruststütze**  
 Chest support

17-060-00



**Sternberg**

12,0 cm 17-070-12  
 14,0 cm 17-070-14  
 16,0 cm 17-070-16



**Collin**

16,0 cm 17-072-16  
 18,0 cm 17-072-18



**Young**

16,0 cm 17-073-16



17-073-99



**Bishop**

13,0 cm 17-074-13



**White**

18,0 cm **17-085-18**  
23,5 cm **17-085-23**



**Blohmke**

20,5 cm **17-093-20**



**Ballenger**

21,5 cm **17-094-21**



**Marschik**

22,0 cm **17-096-22**



**Carpenter**

25,0 cm 17-100-01

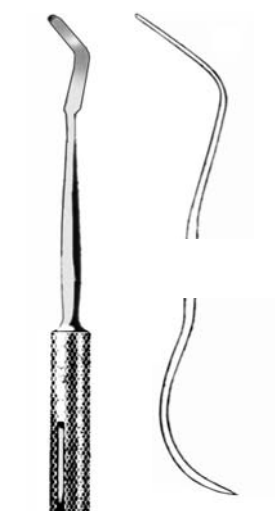

24,0 cm 17-100-02

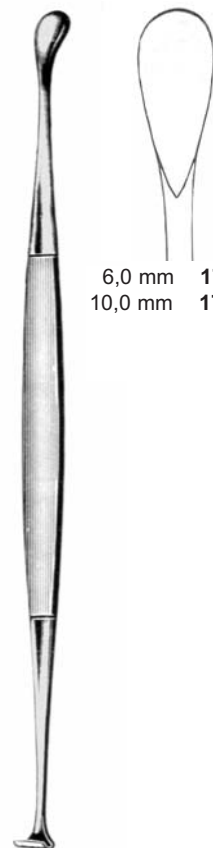

**Hurd, 21,5 cm**

6,0 mm 17-101-01  
10,0 mm 17-101-02



**Henke, 23,5 cm**

10,0 mm 17-102-01  
17,0 mm 17-102-02



**Abraham**

21,5 cm 17-106-21



**Brünings, 21,5 cm**  
 17-107-21



**Fisher, 20,5 cm**  
 17-109-20



**Eves**

25,0 cm 17-150-25 **ohne Sperre**  
 without catch  
 25,0 cm 17-152-25 **mit Sperre**  
 with catch



**Roeder**

26,5 cm 17-153-26



**Brünings**

27,0 cm 17-154-27



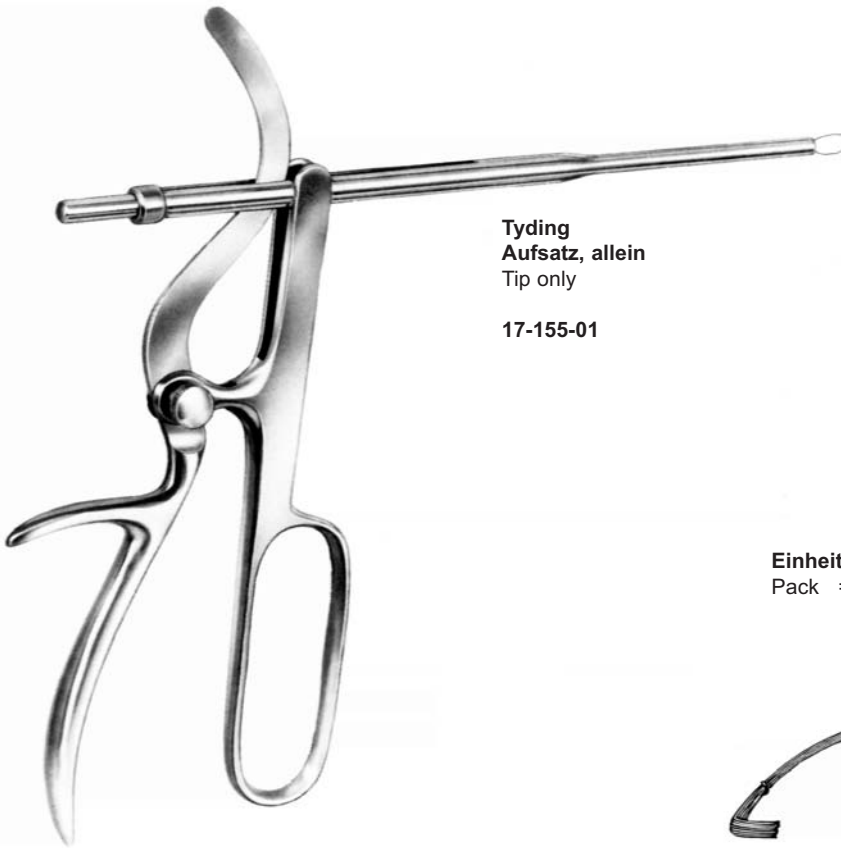

**Tyding**  
**Aufsatz, allein**  
Tip only

17-155-01

**Tyding**  
**mit Aufsatz**  
with tip

17-155-00

**Einheit = 12 Stück**  
Pack = 12 pieces

**Einheit = 100 Stück**  
Pack = 100 pieces



17-156-03 Ø 0,3 mm  
17-156-05 Ø 0,5 mm



17-157-04 40,0 mm  
17-157-05 50,0 mm



**Sluder-Ballenger**  
**komplett mit 3 Aufsätzen**  
complete with 3 tips  
17-159-00

**Griff allein**  
Handle only  
17-159-04  
Handle only

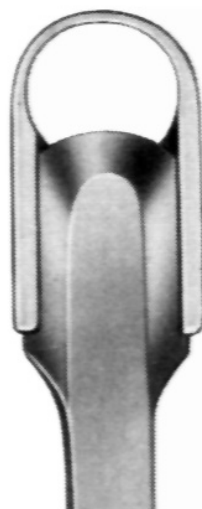

Fig. 1  
17-159-01



Fig. 2  
17-159-02

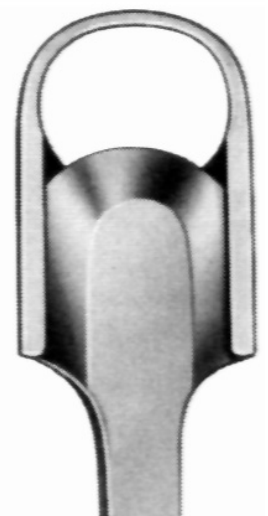
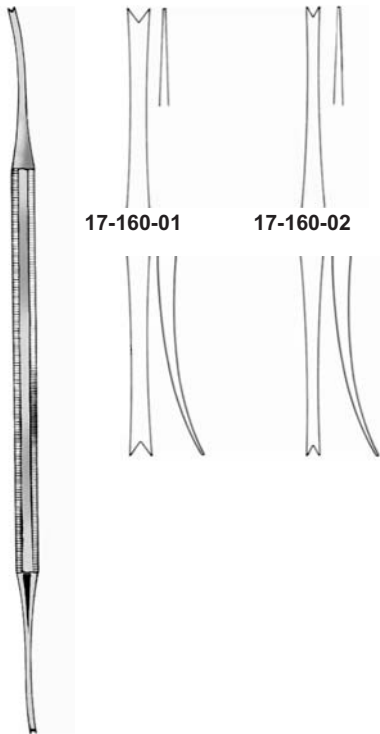
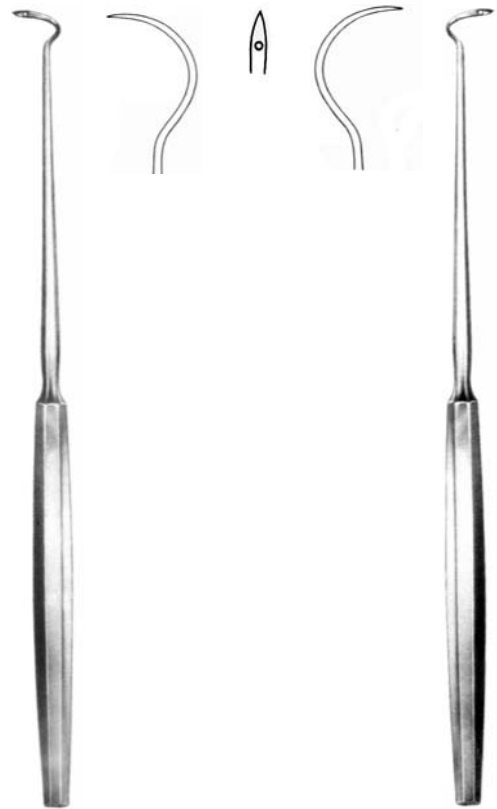

Fig. 3  
17-159-03



Luniatschek, 18,0 cm



Hurd

Hurd

21,0 cm 17-163-21

21,0 cm 17-165-21



Von Eicken

25,0 cm 17-167-25

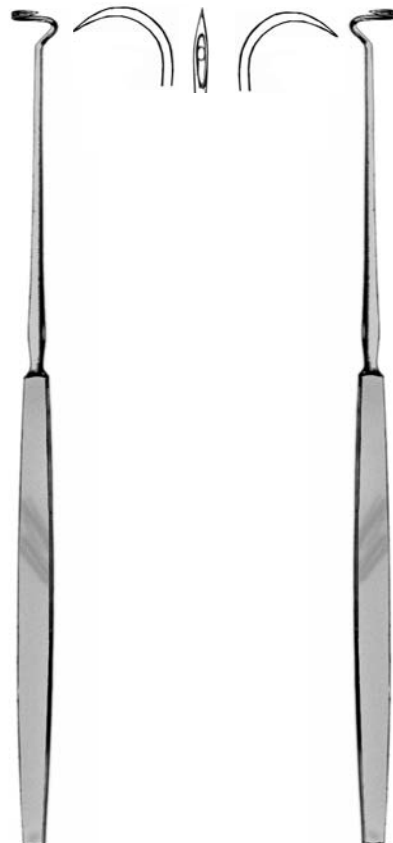

Dupuy Weiss, 22,0 cm

17-169-22

17-171-22



Nager

23,0 cm 17-175-23



Fig. 1  
17-181-01  
17-183-01



Fig. 2  
17-181-02  
17-183-02



Fig. 3  
17-181-03  
17-183-03



Fig. 4  
17-181-04  
17-183-04



Fig. 5  
17-181-05  
17-183-05



Fig. 6  
17-181-06  
17-183-06



Beckmann, 22,0 cm

17-181-01 - 17-181-06      17-183-01 - 17-183-06



La Force, 23,0 cm

Fig. 1 17-187-01  
Fig. 2 17-187-02  
Fig. 3 17-187-03

Ersatzklingen, Spare Blades



Fig. 1  
17-187-11



Fig. 2  
17-187-12



Fig. 3  
17-187-13



- 17-200-08
- 17-200-10
- 17-200-12
- 17-200-14
- 17-200-16
- 17-200-18
- 17-200-20
- 17-200-22
- 17-200-24
- 17-200-26
- 17-200-28
- 17-200-30



- Fig. 00 Ø 8,0 mm
- Fig. 0 Ø 10,0 mm
- Fig. 1 Ø 12,0 mm
- Fig. 2 Ø 14,0 mm
- Fig. 3 Ø 16,0 mm
- Fig. 4 Ø 18,0 mm
- Fig. 5 Ø 20,0 mm
- Fig. 6 Ø 22,0 mm
- Fig. 7 Ø 24,0 mm
- Fig. 8 Ø 26,0 mm
- Fig. 9 Ø 28,0 mm
- Fig. 10 Ø 30,0 mm



- 17-210-08
- 17-210-10
- 17-210-12
- 17-210-14
- 17-210-16
- 17-210-18
- 17-210-20
- 17-210-22
- 17-210-24
- 17-210-26
- 17-210-28
- 17-210-30



11,0 cm  
 17-201-00



11,0 cm  
 17-202-00



Ø 12,0 mm  
 17-230-12



Ø 14,0 mm  
 17-230-14



Ø 16,0 mm  
 17-230-16



Ø 18,0 mm  
 17-230-18



Michel, 25,0 cm

17-230-12 - 17-230-18



**Reichert**

23,0 cm 17-241-23

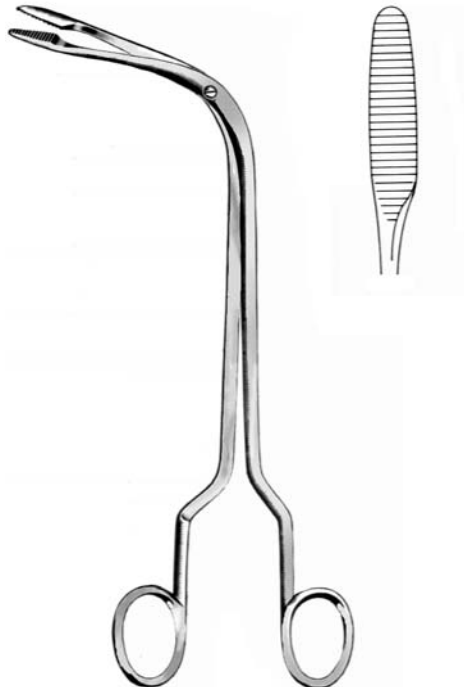

**Fränkel**

22,0 cm 17-247-22



17-251-01



17-251-02



17-251-03



17-251-04

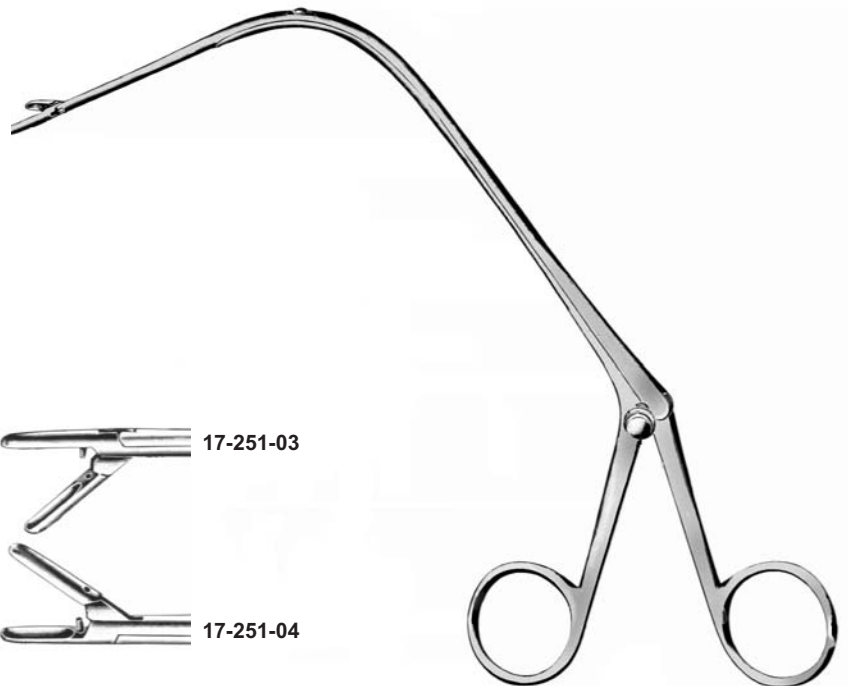

**Jurasz, 22,0 cm**

**Brünings**

**Ansatzrohr starr, gerade**  
 Straight Tubes with Stylet, stiff  
 20,0 cm 17-262-20  
 30,0 cm 17-262-30  
 40,0 cm 17-262-40  
 50,0 cm 17-262-50



**Brünings**

**Ansatzrohr starr, gebogen**  
 Curved Tubes with Stylet, stiff  
 20,0 cm 17-267-20

**Ansatzrohr biegsam, gebogen**  
 Curved Tubes with Stylet, malleable  
 20,0 cm 17-268-20

**Fränkel**  
 17-270-01



**Kahler**  
 17-270-02



**Fränkel**  
 17-270-04



**Huber Universal-Griff**  
 17-262-00

**Scheinmann**  
 17-270-06



**Scheinmann**  
 17-270-15



**Brünings**  
 17-270-08  
 17-270-09



**Schumacher**  
 17-270-16



**Lange**  
 17-270-11



**Cordes**  
 17-270-17  
 17-270-18



**Krause**  
 17-270-13  
 17-270-14



**Rosenberg**  
 17-270-19





**Trousseau**

12,0 cm 17-315-12



**Laborde**

13,5 cm 17-317-13



**Iterson, 17,0 cm**



17-321-01



17-321-02



17-323-01



17-323-02

**Bose, 16,5 cm**



**Rose**

13,5 cm 17-325-13



**Luer**

11,0cm 17-327-11



**Jackson**

15,0 cm 17-329-15



**News**

15,0 cm 17-331-15

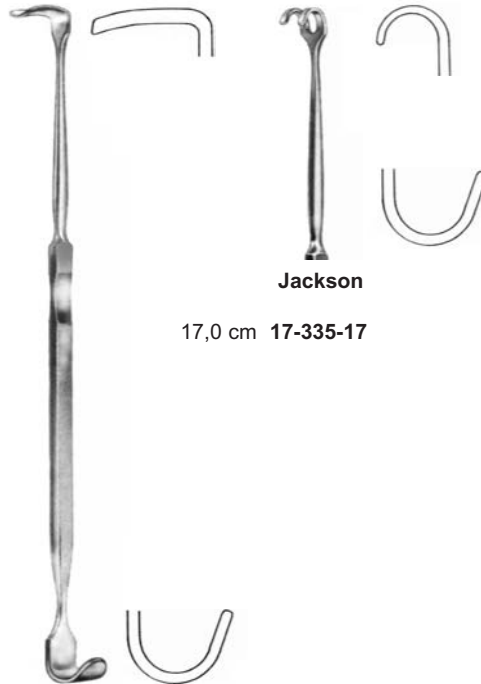

**Lukens**

17,0 cm 17-333-17

**Jackson**

17,0 cm 17-335-17



**Schoenborn**

20,5 cm 17-337-21



**Kocher**



15,0 cm  
 17-339-01

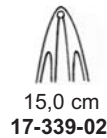

15,0 cm  
 17-339-02



17,0 cm  
 17-339-03



**Lahey**

15,0 cm 17-340-15  
 20,0 cm 17-340-20







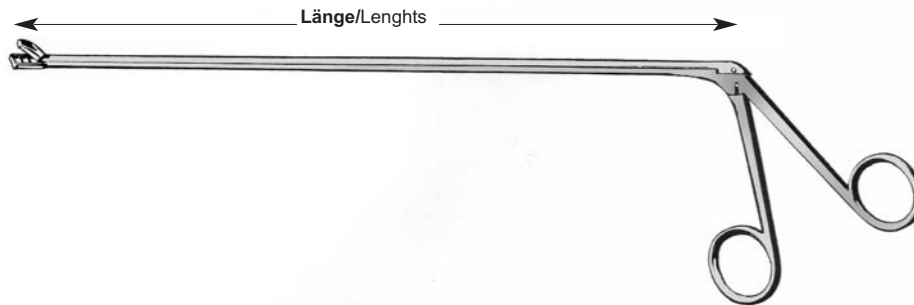

**Mastin**

15,0 cm 17-341-17





	Schaft 30 cm Shaft 30 cm	Schaft 40 cm Shaft 40 cm	Schaft 50 cm Shaft 50 cm	Schaft 60 cm Shaft 60 cm	
	17-410-30	17-410-40	17-410-50	17-410-60	<b>Probeextensions-Zange</b> Biopsy Punch
	17-411-30	17-411-40	17-411-50	17-411-60	<b>Probeextensions-Zange</b> Biopsy Punch
	17-412-30	17-412-40	17-412-50	17-412-60	<b>Alligatorzange</b> Alligator Forceps
	17-413-30	17-413-40	17-413-50	17-413-60	<b>Löffelzange</b> Cup-shaped Forceps
	17-414-30	17-414-40	17-414-50	17-414-60	<b>Probeextensions-Zange</b> Biopsy Punch
	17-415-30	17-415-40	17-415-50	17-415-60	<b>Faßzange</b> Grasping Forceps
	17-416-30	17-416-40	17-416-50	17-416-60	<b>Löffelzange</b> Cup-shaped Forceps



**Steckschluß**  
 aseptic joint  
**Schraubschluß**  
 screw joint

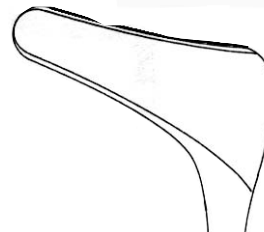
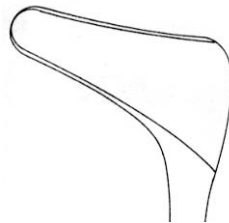
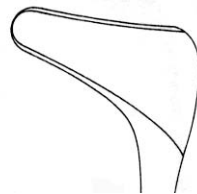
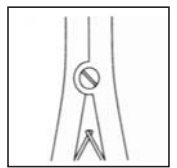
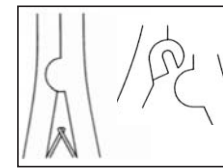

**Steckschluß**  
 aseptic joint  
**Schraubschluß**  
 screw joint

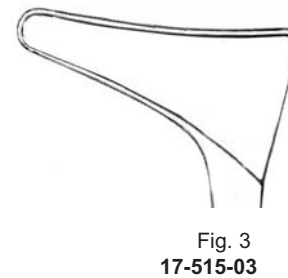
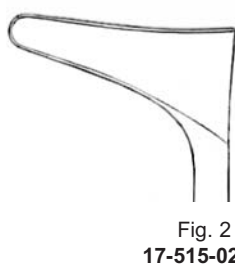
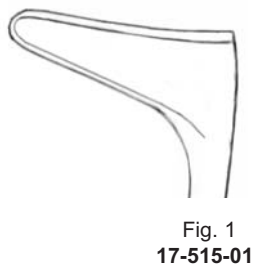

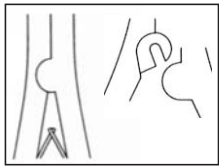

**Steckschluß**  
aseptic joint

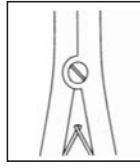

**Schraubschluß**  
screw joint



17-519-14



17-519-15



**Beckmann**

**Steckschluß/screw joint**  
**Schraubschluß/aseptic joint**

Fig. 1  
17-524-01  
17-525-01

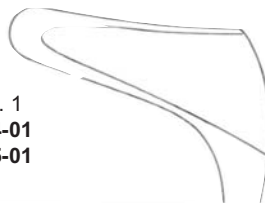

**Steckschluß/screw joint**  
**Schraubschluß/aseptic joint**

Fig. 2  
17-524-02  
17-525-02



**Steckschluß/screw joint**  
**Schraubschluß/aseptic joint**

Fig. 3  
17-524-03  
17-525-03

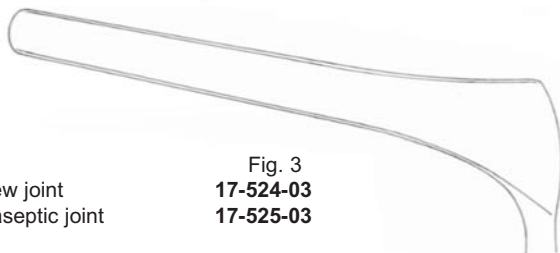

**Steckschluß/screw joint**  
**Schraubschluß/aseptic joint**

Fig. 4  
17-524-04  
17-525-04

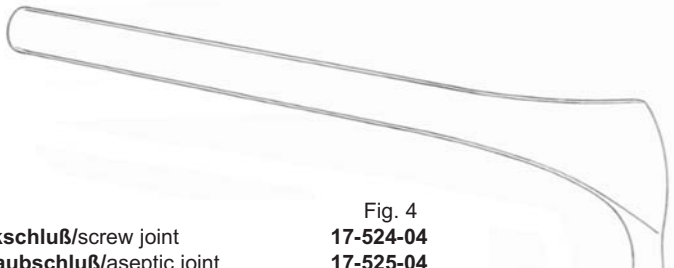

**Killian**



**Cottle**

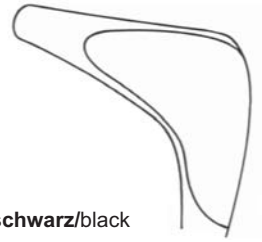

Fig. 1  
 17-528-01  
 17-530-01 schwarz/black

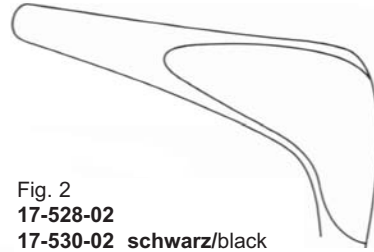

Fig. 2  
 17-528-02  
 17-530-02 schwarz/black

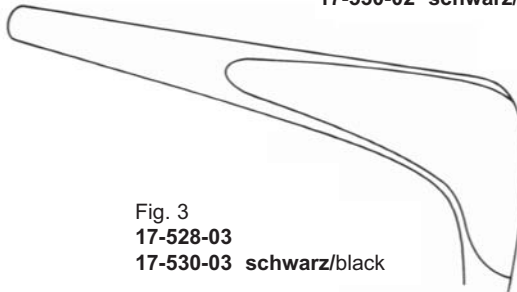

Fig. 3  
 17-528-03  
 17-530-03 schwarz/black

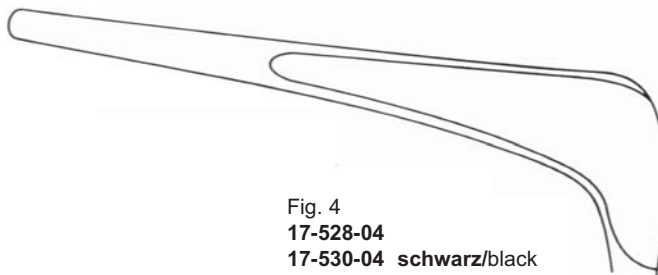

Fig. 4  
 17-528-04  
 17-530-04 schwarz/black

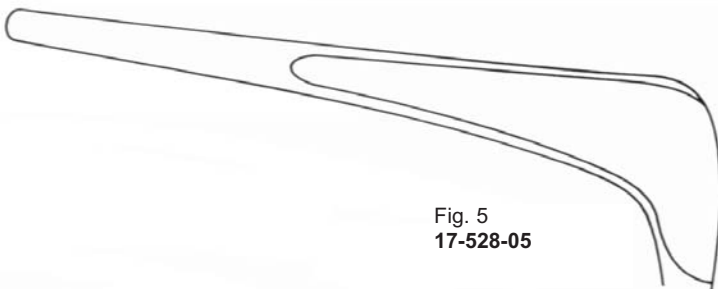

Fig. 5  
 17-528-05



**Cottle**  
 schwarz verchromt  
 black chromium plating



**Lubet-Barbon**

20,0 cm 17-603-20

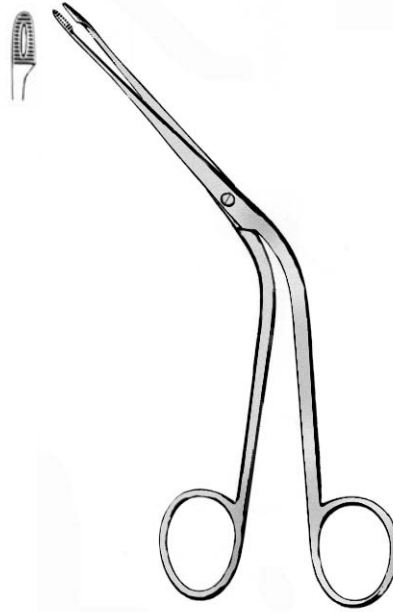

**Hartmann**

16,0 cm 17-607-16

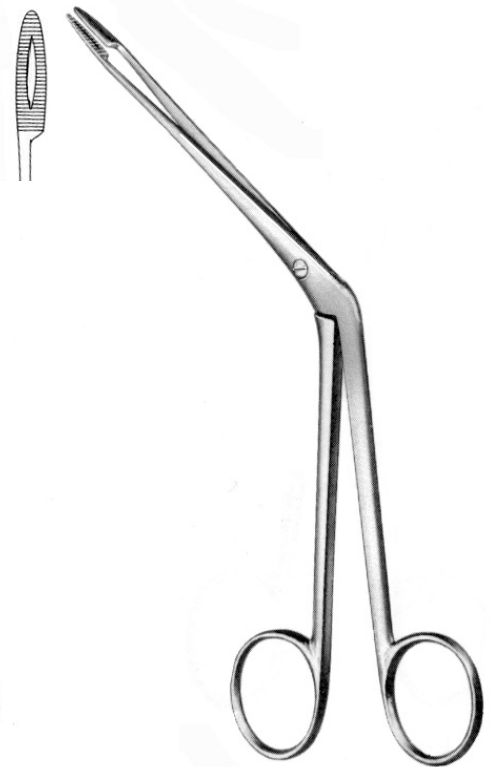

**Hartmann**

20,0 cm 17-607-20



**Heymann**

18,0 cm 17-609-18



**Littauer**

18,0 cm 17-611-18

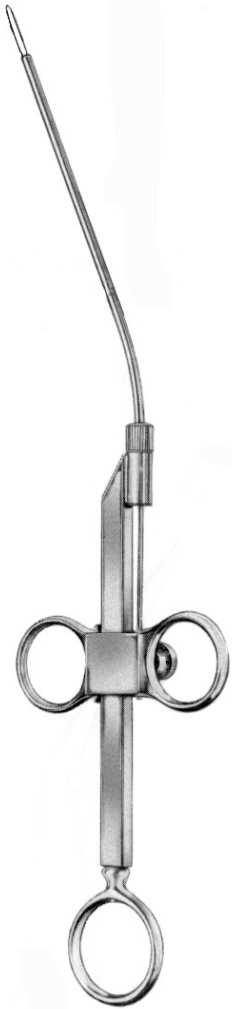

**Krause**

26,0 cm 17-621-26



17-627-99  
 0,3 mm Ø

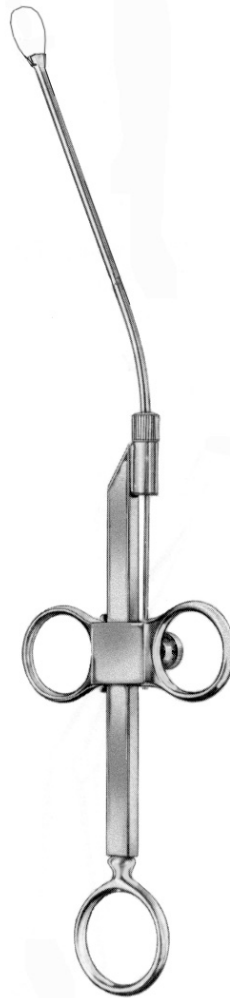

**Krause-Voss**

26,0 cm 17-623-26



**Joseph, 14,5 cm**

17-640-14

17-641-14



**Brünings**

16,0 cm 17-642-16



**Fomon**

16,0 cm 17-645-16



**Freer**

15,5 cm 17-646-15

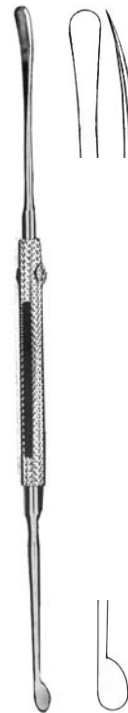

**Freer**

18,5 cm 17-646-18



19,0 cm **Sichelmesser**  
 Sickle Knife



17-648-01



17-648-02



17-648-03



**Converse**

16,0 cm 17-649-16



**Joseph**

15,0 cm 17-650-15



**Cottle**

15,0 cm 17-652-15



**Cottle**

15,0 cm 17-654-15



**Halle**

18,0 cm 17-655-18

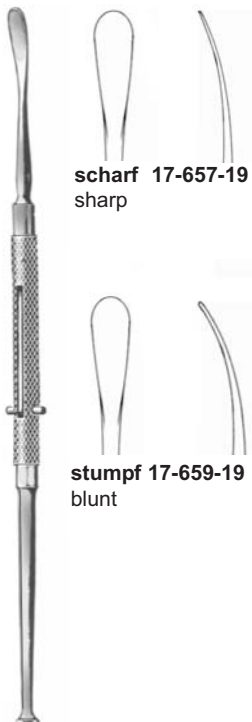

**scharf / sharp** 17-657-19

**stumpf / blunt** 17-659-19

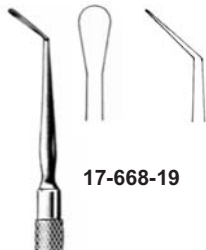

17-668-19



17-669-01



17-669-02



**scharf / sharp**

**stumpf / blunt**

**Freer**

18,0 cm 17-663-18



**scharf / sharp**

**stumpf / blunt**

**Freer**

20,0 cm 17-665-20

**Freer, 19,0 cm**

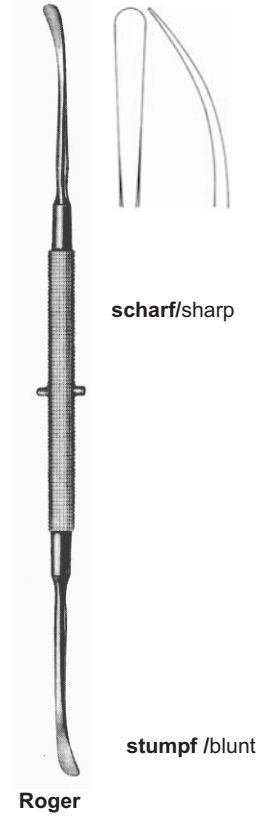
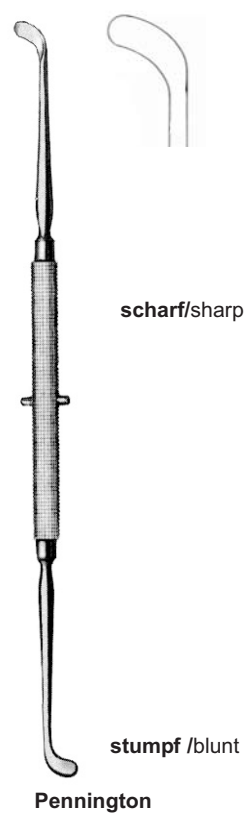
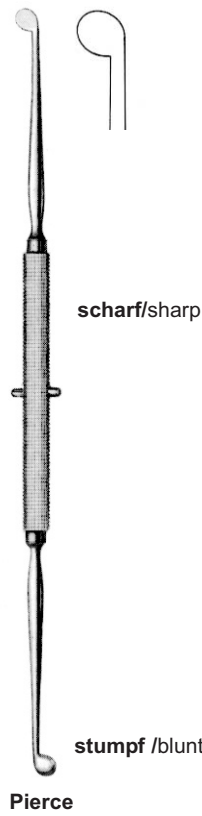
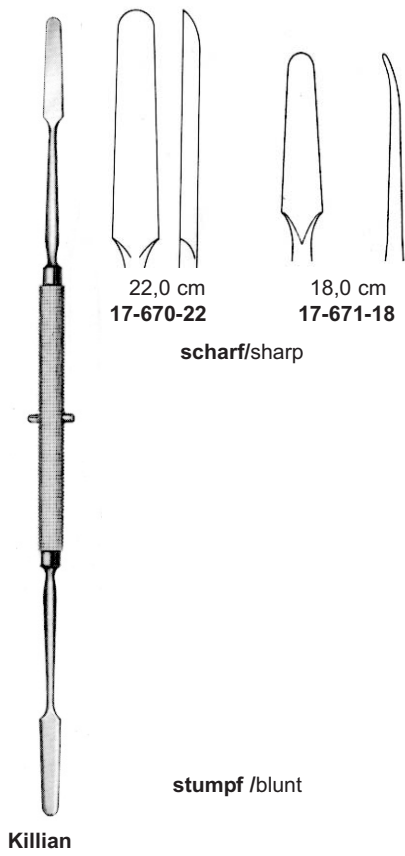

21,0 cm 17-672-21

21,0 cm 17-673-21

19,0 cm 17-675-19



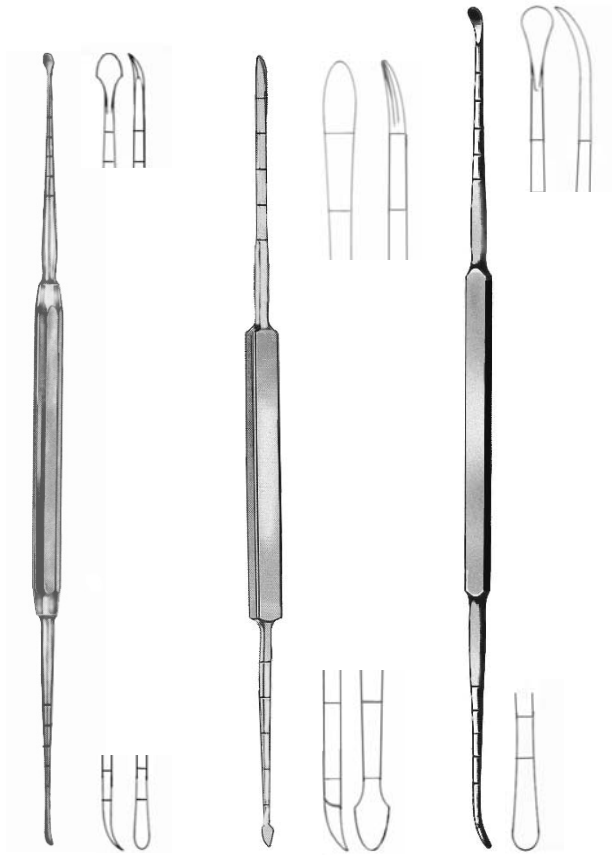

**Massing**

**Cottle**

**Cottle**

21,0 cm 17-679-21

21,0 cm 17-681-21

22,0 cm 17-681-22

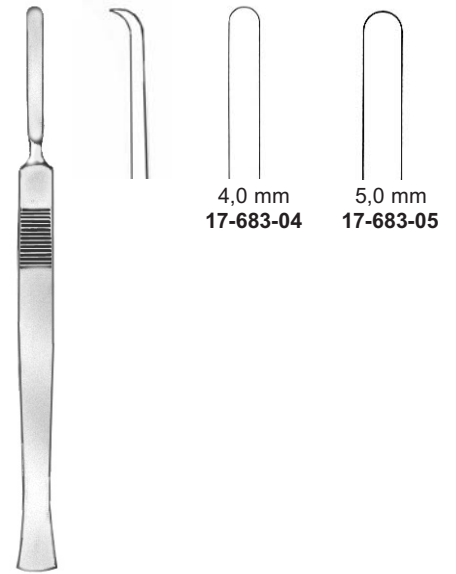

**McKenty, 15,0 cm**

4,0 mm  
17-683-04

5,0 mm  
17-683-05

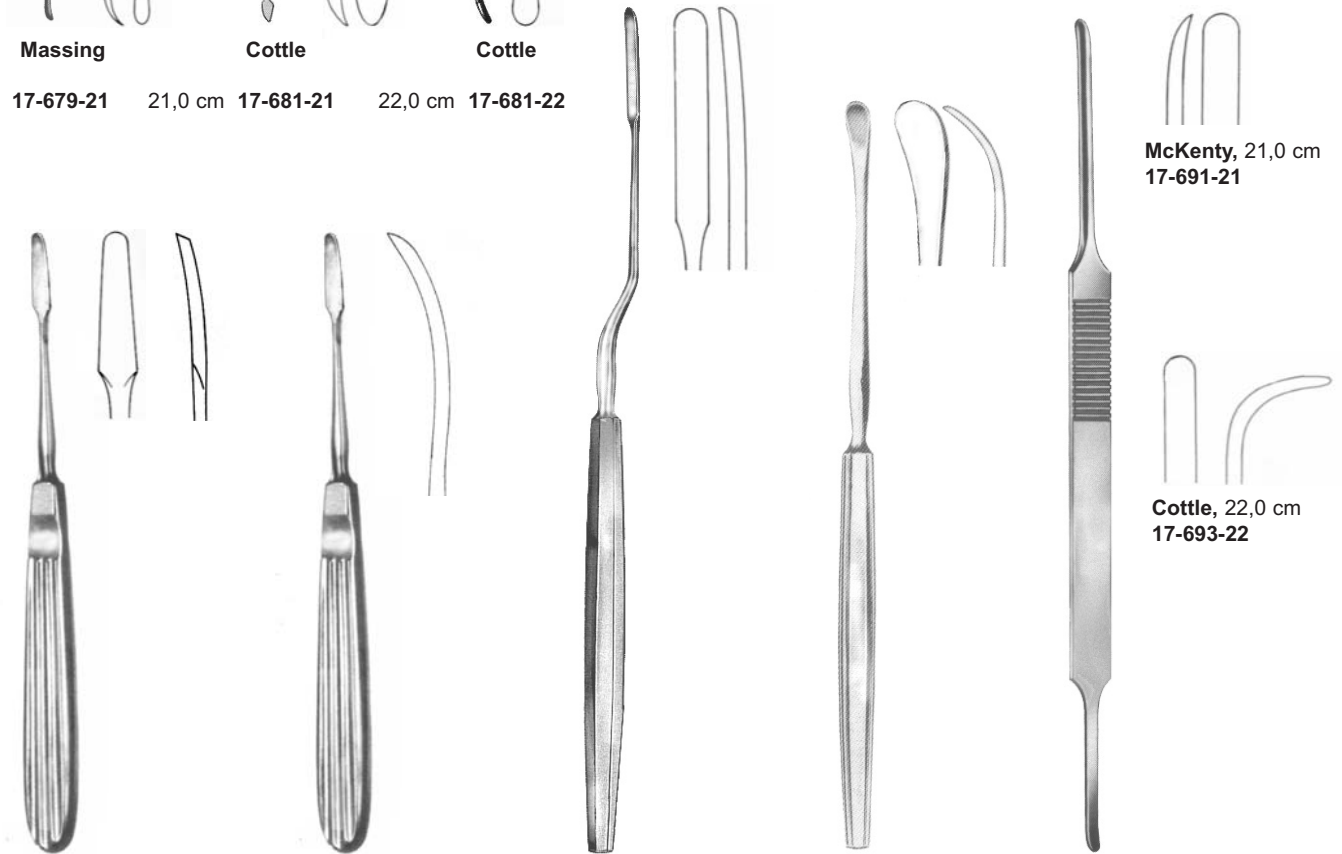

**Joseph**

**Joseph**

**Joseph**

**Sewall**

**McKenty, 21,0 cm  
17-691-21**

**Cottle, 22,0 cm  
17-693-22**

16,0 cm 17-685-16

16,0 cm 17-687-16

22,0 cm 17-688-22

20,0 cm 17-689-20



**Freer, 16,0 cm**  
**17-701-16**

16,0 cm **17-700-16**



**Freer**

15,0 cm **17-702-15**

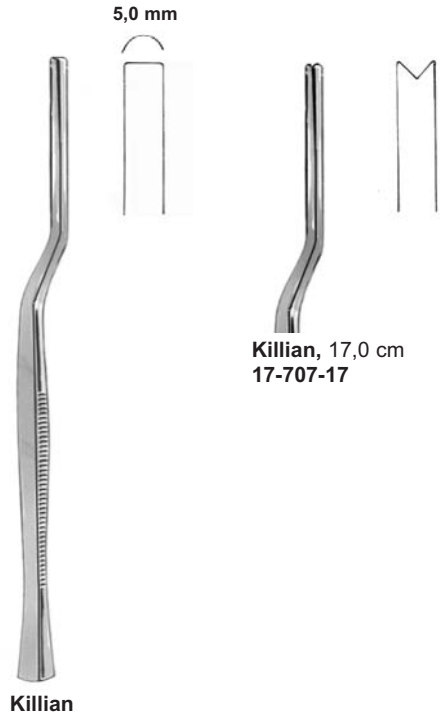

**Killian, 17,0 cm**  
**17-707-17**

17,0 cm **17-705-17**



**Ballenger**

**17-710-03 - 17-710-05**

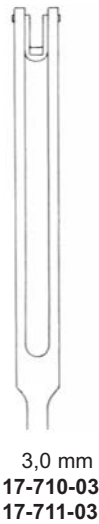

**3,0 mm**  
**17-710-03**  
**17-711-03**



**4,0 mm**  
**17-710-04**  
**17-711-04**



**5,0 mm**  
**17-710-05**  
**17-711-05**



**Ballenger**

**17-711-03 - 17-711-05**

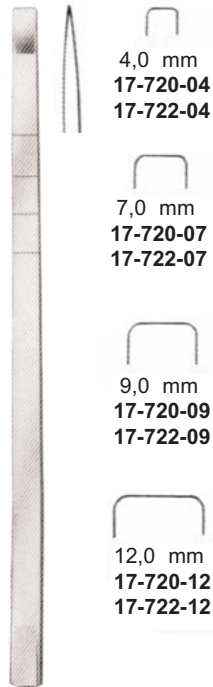

4,0 mm  
 17-720-04  
 17-722-04

7,0 mm  
 17-720-07  
 17-722-07

9,0 mm  
 17-720-09  
 17-722-09

12,0 mm  
 17-720-12  
 17-722-12

**Cottle, 18,0 cm**

17-720-04 - 17-720-12



**Cottle, 18,0 cm**  
 17-722-04 - 17-722-12

6,0 mm

**Cottle, 18,0 cm**  
 17-721-06

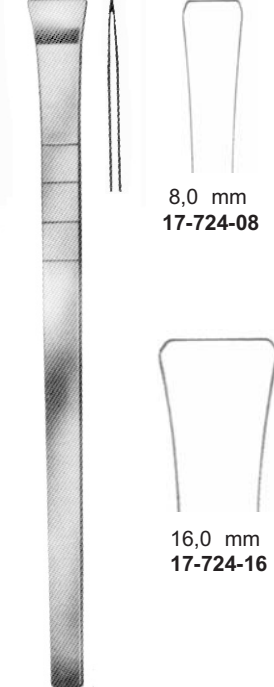

8,0 mm  
 17-724-08

16,0 mm  
 17-724-16

**Cottle, 18,0 cm**

17-724-08 - 17-724-16

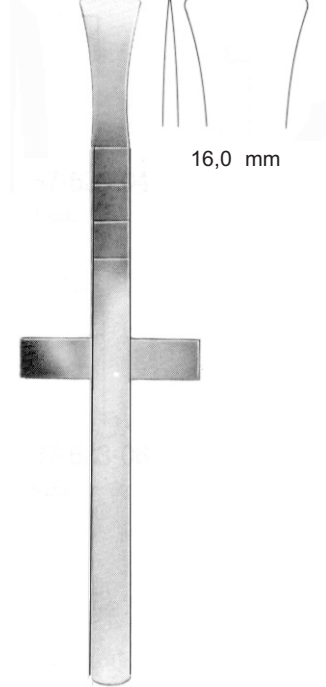

16,0 mm

**Cottle, 18,0 cm**

17-726-16

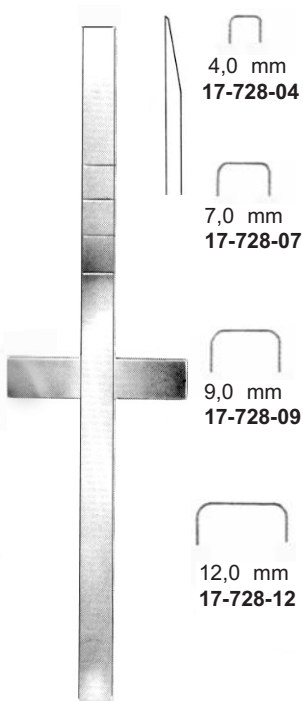

4,0 mm  
 17-728-04

7,0 mm  
 17-728-07

9,0 mm  
 17-728-09

12,0 mm  
 17-728-12

**Cottle, 18,0 cm**

17-728-04 - 17-728-12

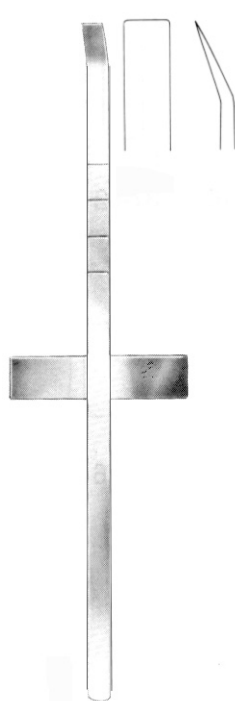

6,0 mm

**Cottle, 18,0 cm**

17-729-06

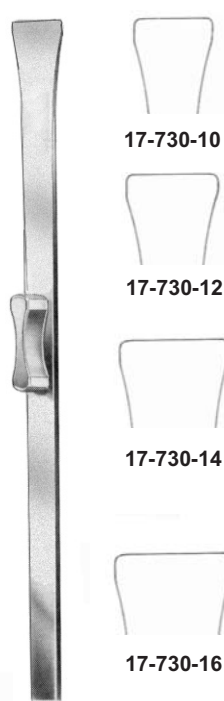

17-730-10

17-730-12

17-730-14

17-730-16

**Rubin, 18,0 cm**

17-730-10 - 17-730-16

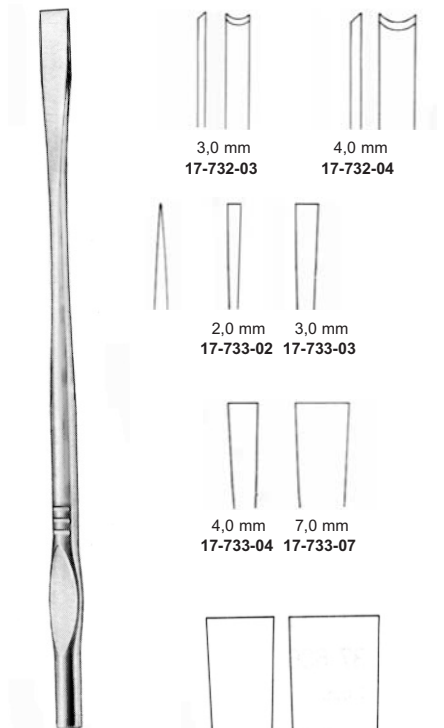

3,0 mm  
 17-732-03

4,0 mm  
 17-732-04

2,0 mm  
 17-733-02

3,0 mm  
 17-733-03

4,0 mm  
 17-733-04

7,0 mm  
 17-733-07

9,0 mm  
 17-733-09

12,0 mm  
 17-733-12

**Walter, 19,0 cm**



**Fomon, 17,0 cm**



4,0 mm  
**17-736-04**



5,0 mm  
**17-736-05**



6,0 mm  
**17-736-06**

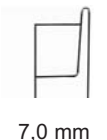

7,0 mm  
**17-736-07**



**Cinelli, 16,0 cm**

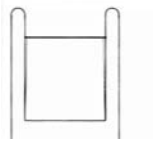

10,0 mm  
**17-740-10**

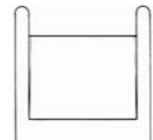

12,0 mm  
**17-740-12**

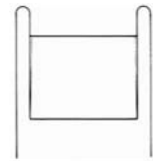

14,0 mm  
**17-740-14**

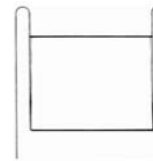

16,0 mm  
**17-740-16**



**Massing, 17,5 cm**



**17-741-01**



**17-741-02**



**17-741-03**

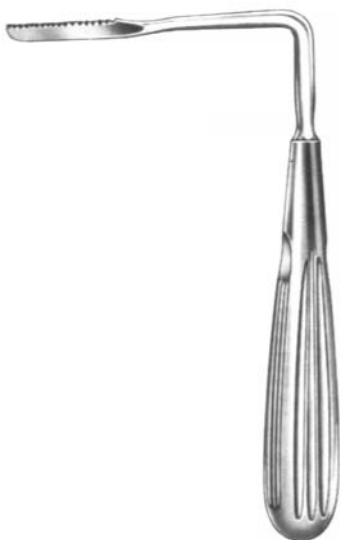

**Joseph**

17,0 cm **17-751-01**



**17-751-02**



**17-752-01**

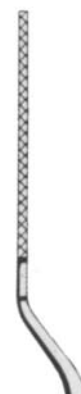

**17-752-02**



**17-752-03**



**Cottle, Knorpelquetschinstrument/Bone crusher**

17-756-00



**Columella**

10,0 cm 17-760-10



**Cottle**

14,0 cm 17-761-14



**Graefe**

11,0 cm 17-762-11



**Aufricht**

16,0 cm 17-767-16



**Walter**

13,5 cm 17-769-13



**Kilner, 10,0 cm**

scharf 17-770-10  
 sharp

stumpf 17-770-11  
 blunt



**Converse**

12,0 cm 17-771-12



**Cottle, 15,0 cm**



17-772-01



17-772-02



17-772-03

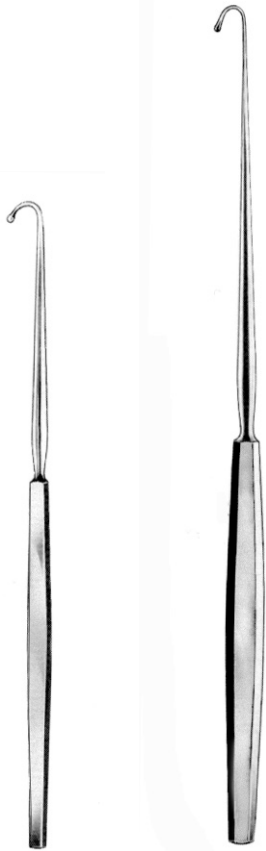

**Fomon**

17,0 cm 17-776-17

**Lange**

22,0 cm 17-777-22

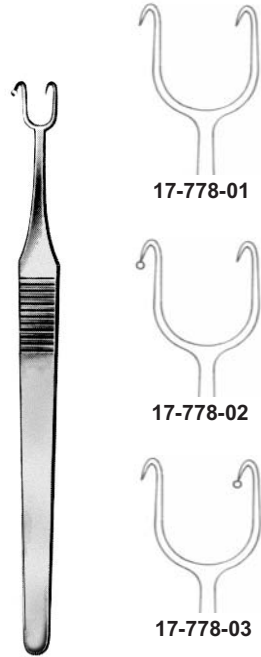

17-778-01

17-778-02

17-778-03

**Cottle, 15,0 cm**

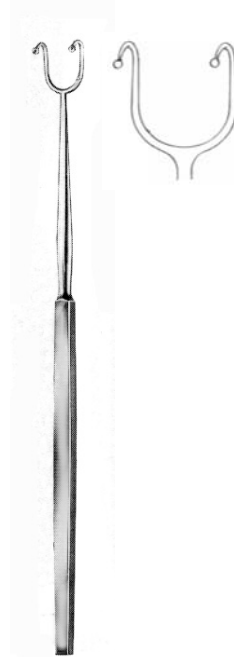

**Fomon**

16,0 cm 17-779-16



**Cottle**

20,0 cm 17-780-20



**Neifert**

16,0 cm 17-782-16



**Massing, 14,0 cm**

6x12 mm 17-783-01  
 10x12 mm 17-783-02



**Cottle**

15,0 cm 17-785-15



**Coakley, 17,0 cm**

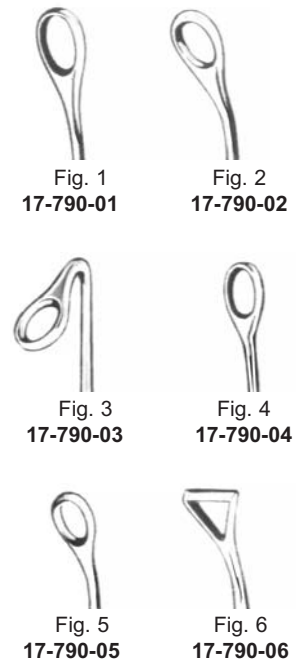

Fig. 1  
 17-790-01

Fig. 2  
 17-790-02

Fig. 3  
 17-790-03

Fig. 4  
 17-790-04

Fig. 5  
 17-790-05

Fig. 6  
 17-790-06



Craig, 17,0 cm



17-801-01



17-803-01



17-803-02

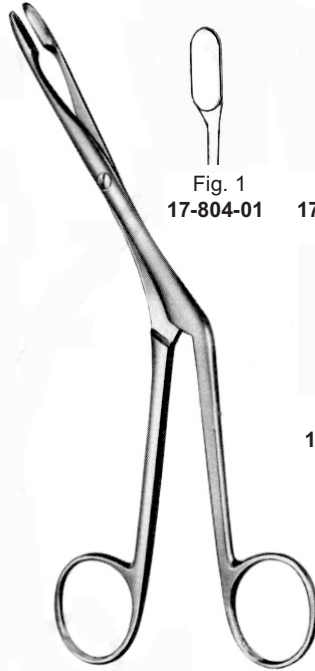

Heymann

18,0 cm 17-804-01



Fig. 1  
17-804-01



Fig. 2  
17-804-02



Fig. 3  
17-804-03

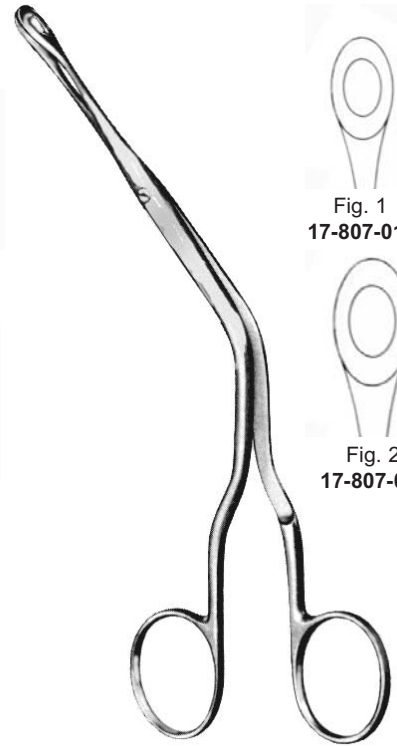

Luc, 20,0 cm



Fig. 1  
17-807-01



Fig. 2  
17-807-02



Luc, 20,0 cm



Fig. 1  
17-811-01



Fig. 2  
17-811-02



Brünings, 19,0 cm



Fig. 1  
17-813-01



Fig. 2  
17-813-02



Fig. 3  
17-813-03

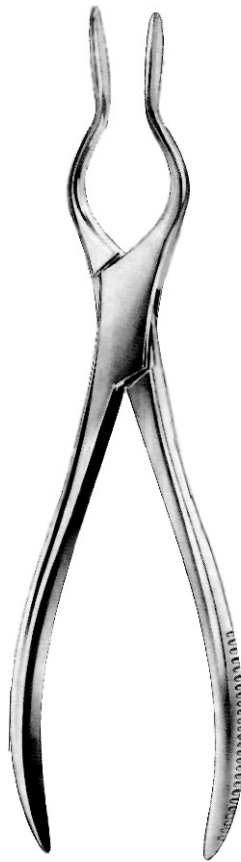

Fig. 4  
17-813-04



**Ash**

22,0 cm 17-825-22



**Cottle-Walsham, 22,0 cm**



Fig. 1  
17-826-01



Fig. 2  
17-826-02



Fig. 3  
17-826-03



**Kressner, 22,0 cm**



3,0 mm  
17-829-03



4,0 mm  
17-829-04





Middleton-Jansen, 19,0 cm

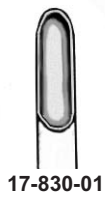

17-830-01



17-830-03  
durchschneidend  
through-cutting

gezahnt/  
serrated



Caplan

20,0 cm 17-841-20

gezahnt/  
serrated

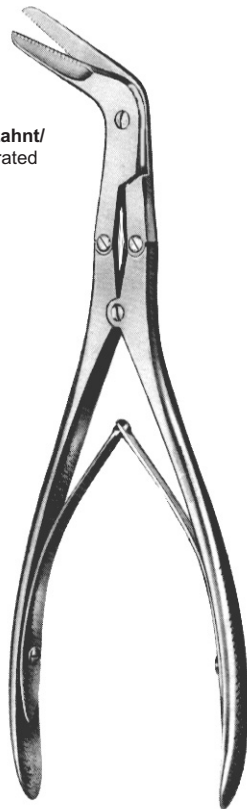

Killian

21,0 cm 17-843-21











Rubin

21,0 cm 17-845-21



kurze Maulöffnung  
 short jaw opening

**Blakesley, extra fein**  
 very delicate

<p><b>Blakesley Nasenzangen</b>            Blakesley Nasal Forceps</p>	 3,0 mm	 3,5 mm	
 <p>gerade straight</p>	<p>17-870-30</p>	<p>17-870-35</p>	
 <p>45°</p>	<p>17-871-30</p>	<p>17-871-35</p>	
<p><b>Blakesley Durchschneidezangen</b>            Blakesley Throughcut Forceps</p>  <p>Schnittbreite bit gerade straight</p>	 2,2 mm  17-880-25 17-880-35	 2,5 mm  17-880-26	 3,0 mm  17-880-35 17-881-65 nach rechts, to the right 17-881-75 nach links, to the left
 <p>45°  rechts/right links/left</p>	<p>17-881-25</p>	<p>17-881-26</p>	<p>17-881-35</p>